

Engineering Drawings (Front Side)

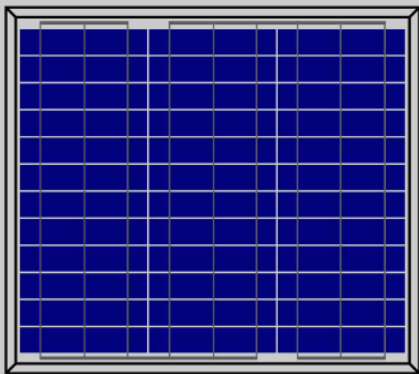

Engineering Drawings (Black Side)

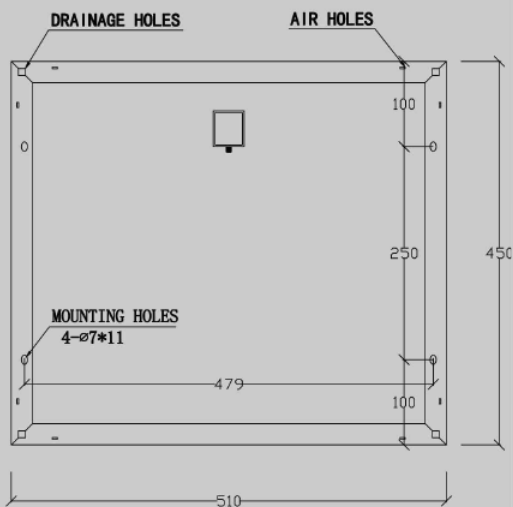

Email: info@linkingsolar.com
 Web: www.linkingsolar.com

Raw materials and Mechanical Parameters

P6-30	
Type of Cells(mm)	Poly156 × 31.2
NO. of Cells and Connections	3 × 12=36
Dimensions(mm)(L*W*H)	450 × 510 × 25
Weight(kg)	2.7
Glass	3.2mm Tempered Glass
Encapsulation	EVA
Backsheet	Multilayer Composite
Aluminium-Frame	Silvery/Black Anodized aluminium alloy
Junction-Box	IP65
Cable	NA, but customized is acceptable
Connector	NA, but MC4 and MC4 Compatible are acceptable
Package Configuration	10 pcs/ctn

Performance Parameters

P6-30	
Maximum System Voltage	700V
Operating Temperature	-45~+80°C
Maximum Series Fuse	--
Maximum Static Load, Front Side (e.x. Snow, Wind)	2400Pa
Maximum Static Load, Back Side (e.x. Wind)	2400Pa
Application Grade	Class A

Electrical Parameters (Standard Test Condition)

P6-30	
Rated Maximum Power(Mp)	30W
Power Tolerance	0- +5W
Cell Efficiency	17.2%
Open Circuit Voltage(Voc)	22.5V
Maximum Power Voltage(Vmp)	17.6V
Short Circuit Current(Isc)	1.82A
Maximum Power Current(Imp)	1.70A
Temperature Coefficient of Isc	+0.06%
Temperature Coefficient of Voc	-0.33%
Temperature Coefficient of Pmp	-0.45%
Standard Test Condition	Irradiance:1000W/M2, Cell Temperature:25°C, Spectrum AM:1.5